

# Accuphase

CLASS-A STEREO POWER AMPLIFIER

## A-75

- Pure Class A stereo power amplifier with outstanding S/N ratio and very high damping factor
- Rated for 60 watts into 8 ohms and 480 watts into 1 ohm
- Power MOS-FETs in 10-parallel push-pull configuration
- Instrumentation amplifier principle
- All signal paths realized with discrete semiconductor components
- Balanced Remote Sensing principle
- MCS+ circuit topology
- Current feedback amplification principle
- Digital power value readout and bar graph voltage indication
- Support for bi-amping and bridged mode





# A New Age Begins — With a Supreme Pure Class A Stereo Power Amplifier.

Instrumentation amplifier topology using discrete semiconductors realizes ideal gain allocation. Balanced Remote Sensing optimizes efficiency of negative feedback. 10-parallel push-pull configuration in power amplification stage. The overall result is outstanding S/N ratio and amazingly high damping factor. Furthermore, constant-voltage drive handles even drastic speaker impedance fluctuations with ease. Power MOS-FETs and other carefully selected components and materials make this Pure Class A Stereo Power Amplifier a sheer delight to experience.

*Technology development ahead of the curve*

## High S/N ratio results in sparkling clarity

The A-75 uses a balanced instrumentation amplifier circuit configuration throughout all amplification stages, minimizing susceptibility to noise and ensuring outstanding characteristics. The signal input stage is configured with discrete semiconductors as a push-pull circuit. This makes it possible to allocate a high gain of 22 dB (factor of approx. 12.6) to this section and conversely keep the gain of the power amplification section to a low 6 dB (approx. x2.0). As a result, even large signal amplitudes are conveyed accurately from the signal input stage to the power amplification stage, and noise components processed in the amplification stage are kept low. Compared to the previous model, this results in a noise reduction of 11%. S/N ratio is rated at an astonishing 122 dB (at max gain setting), which manifests itself in superb sonic clarity.

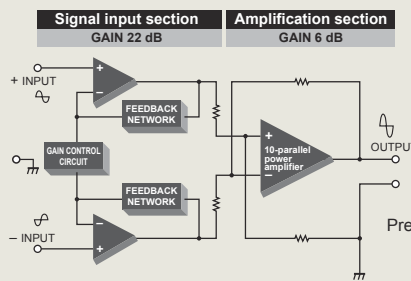

■ Instrumentation amplifier principle



Model	Signal input section
Previous model	19.5 $\mu$ V (S/N ratio: 121 dB)
A-75	17.4 $\mu$ V (S/N ratio: 122 dB)

11% lower

■ Output noise

## High damping factor realizes ideal speaker drive

To correctly track the dynamic changes in loudspeaker impedance and drive the speakers with ideal characteristics, the power amplifier output impedance needs to be kept as low as possible, which in turn means an increase in the damping factor. To achieve this aim, the A-75 not only positions the negative feedback sensing point close to the speaker terminals, it also obtains sensing information from the ground line at the same time. This method is called Balanced Remote Sensing. The aim is to minimize output impedance and therefore achieve a significant increase of the damping factor. Furthermore, ten power MOS-FETs with excellent current capacity are used in a parallel configuration, and MOS-FET switches that eliminate all mechanical contacts guarantee outstanding long-term reliability. The edgewise coil with large cross-section area, Hall element for current detection, and many other sophisticated features further contribute to reduced output impedance. The end result is a damping factor rating of 1,000 which represents a 25% improvement over the previous model.



MOS-FET switches



Edgewise coil

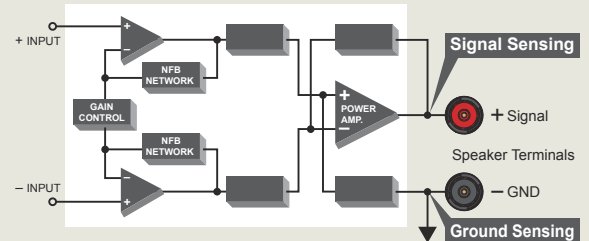

■ Balanced Remote Sensing

Previous model	800
A-75	1000

25% improvement

■ Damping Factor

## Output power characteristics suitable for constant voltage drive

A massive toroidal power transformer and large filtering capacitors (100,000  $\mu$ F x 2) in the power supply ensure that plenty of power is available for handling high amplitude input signals, and large heat sinks efficiently dissipate any excess thermal energy. As a result, the power amplification stage is rated for a continuous 60 watts into 8 ohms, 120 watts into 4 ohms, 240 watts into 2 ohms and 480 watts into 1 ohm (music signals). This linear power progression demonstrates that constant voltage drive has been successfully realized. The maximum output rating is 131 watts into 8 ohms, 232 watts into 4 ohms, 370 watts into 2 ohms and 547 watts into 1 ohm (music signals). Although a Pure Class A Stereo Power Amplifier, the A-75 can easily drive even large and demanding speakers.



Massive toroidal transformer

Power amplification stage with large heat sinks

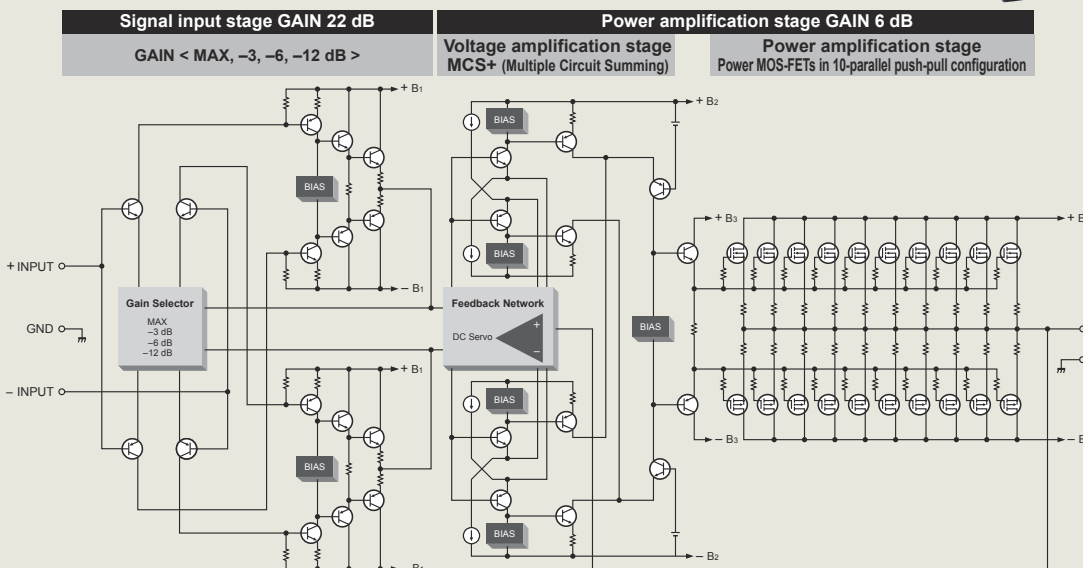
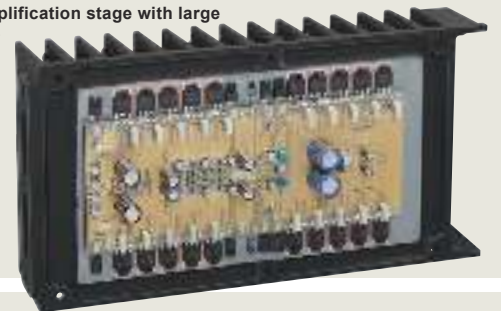

■ Circuit diagram of amplifier section

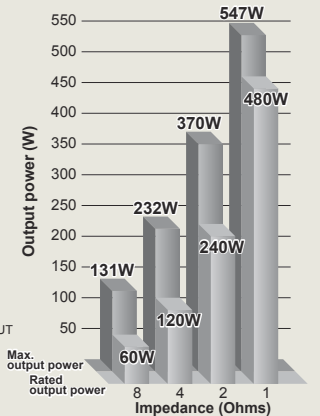

■ Output power characteristics



Power MOS-FETs

## Functionality – Convenience that makes sense



- 1 Meter selector for changing the meter display
- 2 Digital power meter range selector for selecting the power indication range
- 3 Hold time button for changing the value indication hold time

- 4 Input selector button for selecting the input signal
- 5 Gain selector for changing the amplification gain

## Advanced Features

- Current feedback principle in signal input stage and power amplification stage assures excellent phase characteristics in high range.
- MCS+ topology improves S/N ratio and THD characteristics in voltage amplification stage.
- Printed circuit board of power amplification stage made from glass cloth fluorocarbon resin.
- Digital power meter showing output power levels and bar graph meter showing output voltage with indication range to  $-50$  dB, both with on/off switching capability.
- Speaker output short-circuit monitoring function ensures complete operation safety.
- Two sets of large speaker terminals accept spade lugs and also enable easy bi-wiring connection.
- Operation mode switch supports bi-amping and bridged connection.
- 4-stage gain selector.
- Phase selector for balanced inputs.



Digital power meter/bar graph meter



Operation selector



Filtering capacitors



Protection circuit assembly



Top plate with elegant hairline finish

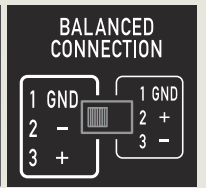

Phase selector

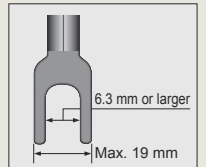

Supported spade lug dimensions



### Connection example for bridged setup

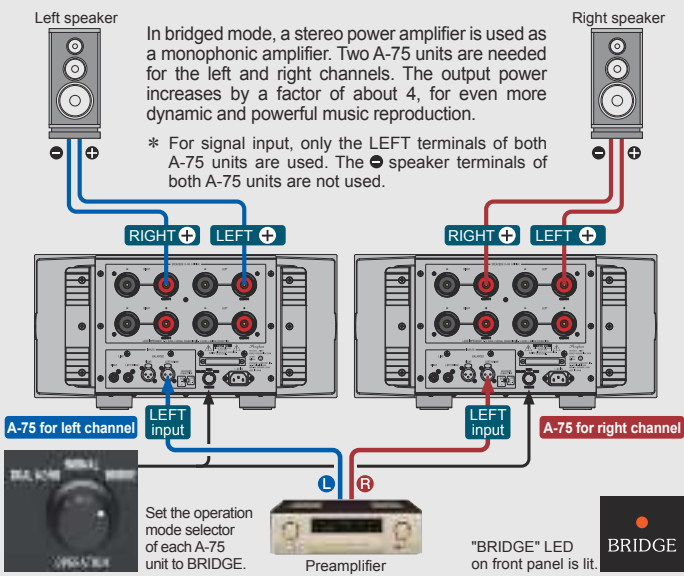

### Example for bi-amping connection

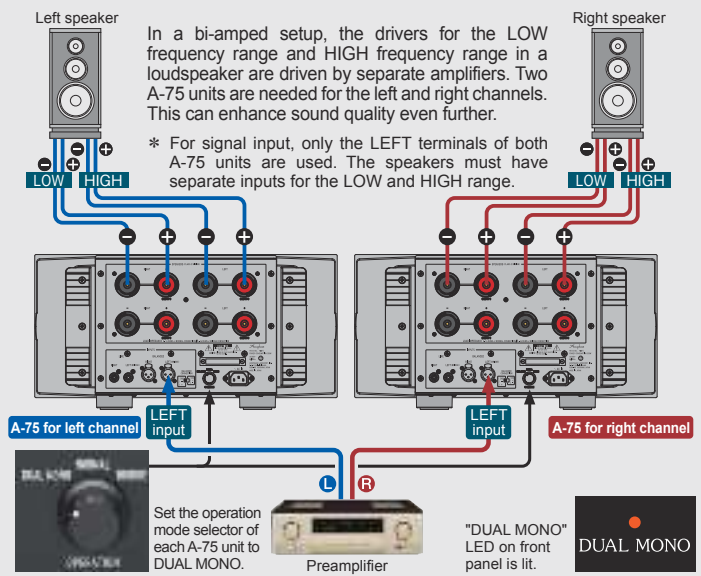

### Front Panel

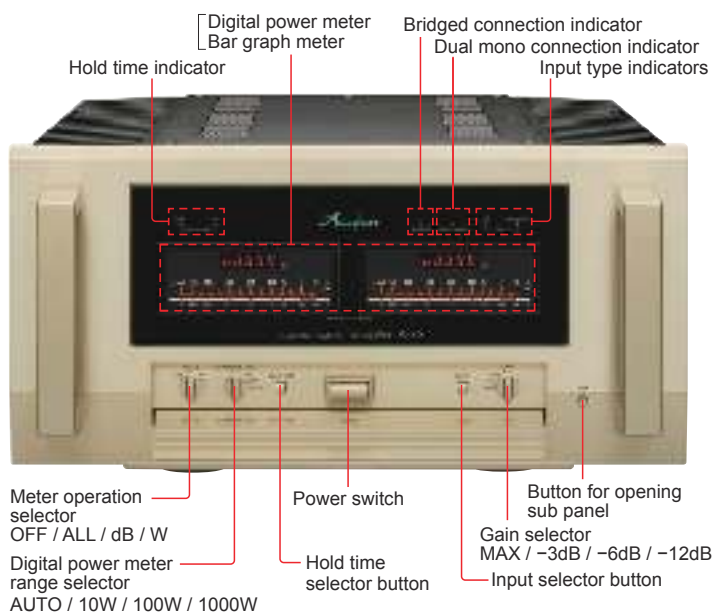

### Rear Panel

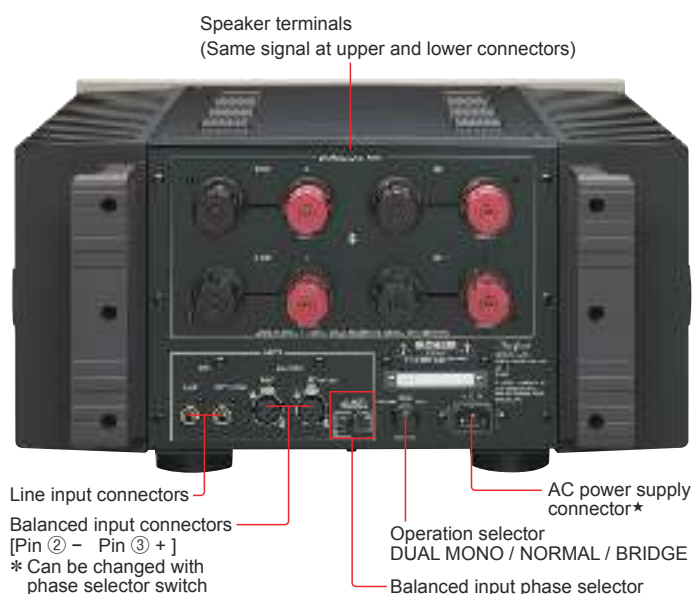

## A-75 GUARANTEED SPECIFICATIONS [Guaranteed specifications are measured according to EIA standard RS-490.]

Continuous Average Output Power (20 - 20,000 Hz) <small>Note: Ratings marked with (*) are for music signals only.</small>			
Stereo operation (both channels driven)	480 W/ch	1-ohm load (*)	
	240 W/ch	2-ohm load	
	120 W/ch	4-ohm load	
	60 W/ch	8-ohm load	
Monophonic operation (bridged connection)	960 W	2-ohm load (*)	
	480 W	4-ohm load	
	240 W	8-ohm load	

Total Harmonic Distortion	Stereo operation (both channels driven)	0.07%	2-ohm load
		0.03%	4 to 16 ohm load
	Monophonic operation (bridged connection)	0.05%	4 to 16 ohm load

Intermodulation Distortion 0.01%

Frequency Response	At rated continuous average output:			
		20 to 20,000 Hz	+0	-0.2 dB
	At 1 watt output:			
	0.5 to 160,000 Hz	+0	-3.0 dB	

Gain 28.0 dB (GAIN selector in MAX position) (Stereo/monophonic operation)

Gain selector	Gain selector	MAX	-3 dB	-6 dB	-12 dB
	Gain (dB)	28	25	22	16

Output Load Impedance	Stereo operation:		
		2 to 16 ohms	
	Monophonic operation:		
	4 to 16 ohms		
	[* With music signals only, 1-ohm loads are permissible for stereo operation and 2-ohm loads for bridged operation.]		

#### Remarks

- ★ This product is available in versions for 120/220/230 V AC. Make sure that the voltage shown on the rear panel matches the AC line voltage in your area.
- ★ The 230 V version has an Eco Mode that switches power off after 120 minutes of inactivity.
- ★ The shape of the AC inlet and plug of the supplied power cord depends on the voltage rating and destination country.

#### Supplied Accessory

- AC power cord

Damping Factor	1000
Input Sensitivity (with 8-ohm load)	Stereo operation 0.87 V for rated continuous average output
	0.11 V for 1 watt output
Input Impedance	Balanced: 40 kilohms, Line (unbalanced): 20 kilohms
	S/N ratio (A-weighted, with input shorted) 122 dB GAIN selector in MAX position
Output Level Meters	Digital power meter Indicates output power (W) with 5 digits
	Bar graph meter Represents output voltage value (dB) using 38 points
Power requirements	120 V, 220 V, 230 V AC (voltage as indicated on rear panel), 50/60 Hz
	Power Consumption 260 watts idle
Maximum Dimensions	520 watts in accordance with IEC 60065
	Width 465 mm (18.31")
Mass	Height 238 mm (9.37")
	Depth 515 mm (20.28")
	43.9 kg (96.8 lbs) net
	54.0 kg (119.0 lbs) in shipping carton



ACCUPHASE LABORATORY, INC.  
G1805Y PRINTED IN JAPAN 850-2211-00(B1)