

Accuphase

PRECISION STEREO PREAMPLIFIER

C-3850

- Revolutionary low-noise "Balanced AAVA Volume Control"
- High-rigidity, high-accuracy volume knob sensor mechanism
- Separate high-efficiency toroidal power transformers for left and right channels
- Selectable preamp gain
- Fully modular construction with separate left/right units for each amplifier stage
- Logic-controlled relays for shortest signal paths
- Independent phase selection for each input position
- Printed circuit boards made from glass cloth fluorocarbon resin
- Massive wood cabinet with natural grain finish





The Ultimate Analog Preamplifier — Balanced AAVA, the supreme volume control system from Accuphase, provides incredible smoothness and complete mastery over the music reproduction process. Outstanding signal/noise ratio prepares the stage for the source to emerge with breathtaking realism, conveying a wealth of acoustic detail such as hardly ever experienced before. The C-3850 represents the pinnacle of 45 years of Accuphase excellence in analog preamplifiers.

Having been founded in 1972, Accuphase commemorated its 40th anniversary by releasing a next-generation beacon model, the Precision Stereo Preamplifier C-3800. It marked a major milestone and was highly lauded by audiophiles around the world as a tour de force in technological excellence, performance, and sound quality. The new Precision Stereo Preamplifier C-3850 continues the challenge and raises the bar even further, bringing together the entire wealth of preamplifier know-how gained by Accuphase over the years. In construction as well as circuit design, it incorporates latest technology realized with components selected through a thorough review process including extended listening tests. The result is an audio instrument that admits no compromise in the pursuit of peerless performance for musical mastery. Conventional volume controls attenuate the input signal by

introducing a resistance (either using a rotary variable resistor or fixed resistors) in the signal path, and then amplifying the result. This makes it inevitable that—along with attenuation—information will be lost and noise will increase at the lower volume level settings that are normally used. By contrast, AAVA does not "turn down" the volume in the ordinary sense. Rather, it switches a combination of V-I amplifiers as required in order to directly change the amplifier gain and thereby achieve the desired volume. This revolutionary approach eliminates impedance changes as well as adverse effects from noise and other factors. Because there is almost no increase in noise, S/N ratio does not suffer at any listening level including the important moderate volume settings. Frequency response remains uniform and sound quality always maintains its full excellence. The C-3850 features a further evolved version

of this principle, called "Balanced AAVA", with two AAVA circuits driven in a parallel balanced configuration. This results in ideal volume control behavior from balanced input to balanced output. In addition, the volume knob and sensor mechanism fashioned with utmost precision from a single highly rigid aluminum block provides silky smooth operation with excellent tactile feel, and also improves the quietness of motor-driven operation. The entire path for all signals from the input connectors to the outputs is fully balanced, and signal purity is further elevated by the use of ultimate-quality parts and materials, ensuring electrical characteristics and sonic excellence of the highest order. With its no-holds-barred use of resources, and its bold realization of latest circuit design, the C-3850 is an analog preamplifier that redefines the state of the art and points the way towards the future.

Balanced AAVA (Accuphase Analog Vari-gain Amplifier) Volume Control

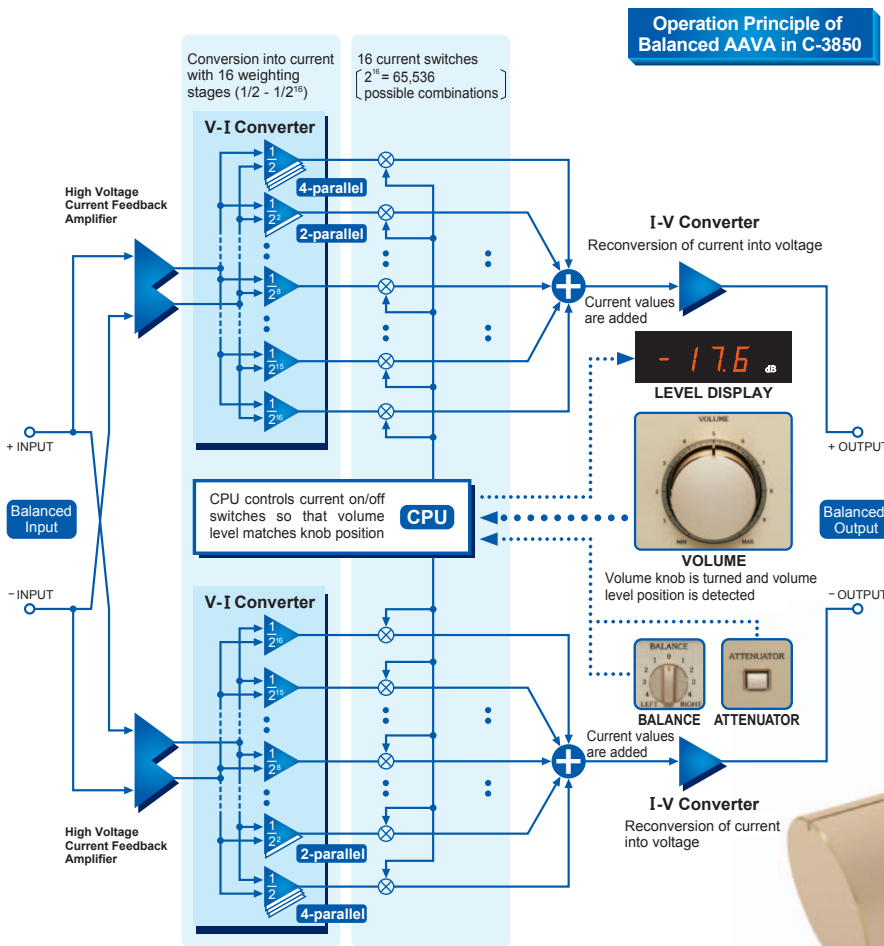

AAVA Operation Principle

The music signal is converted into 16 types of weighted current by V-I (voltage-to-current) converting amplifiers, as shown in the illustration below. The 16 currents are turned on or off by 16 current switches, and the combination of switch settings determines the overall current. The resulting current forms a variable gain circuit that adjusts the volume of the music signal. The respective currents are combined and converted back into a voltage by an I-V (current-to-voltage) converter before being sent to the subsequent stage.

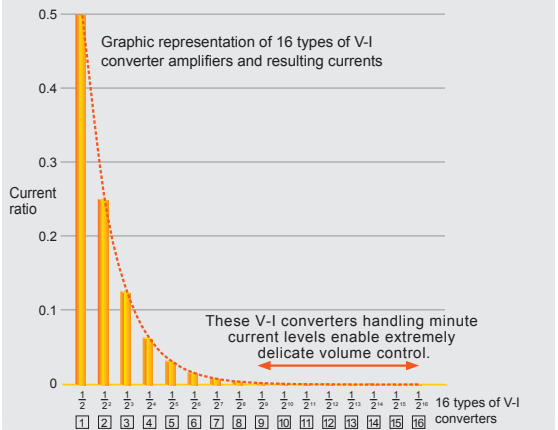

— Extruded from solid aluminum block — High-rigidity volume sensor construction

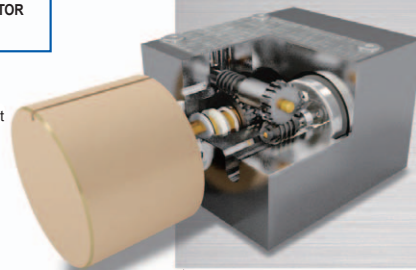

Turning the volume knob on the front panel causes the actual volume level position to be detected. The corresponding signal is sent to a CPU which in turn controls the current switches and thereby the gain of the AAVA circuitry. The massive knob extruded from a solid aluminum block and mounted on large-diameter shaft has exactly the right amount of inertia. Together with the low-friction internal mechanism this provides a silky smooth operation feel and also allows extremely quiet motor-driven operation.

★Cutaway model of volume sensor mechanism

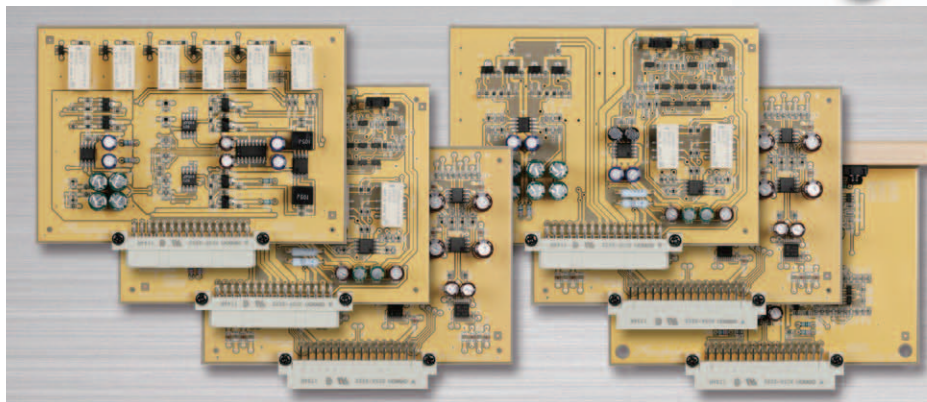

- Upper two V-I converter amplifiers feature a special configuration, with 4-parallel operation for the topmost and 2-parallel operation for the second level, resulting in lower impedance and an amazing S/N ratio improvement of 2 dB.
- No more left/right tracking differences or crosstalk.
- Amplifier display shows accurate gain as numeric indication.
- High S/N ratio, low distortion, uniform frequency response and optimal sound quality maintained at any volume setting.
- Attenuator and balance control also implemented by AAVA, eliminating additional circuitry.
- High-resolution volume control: Combination of V-I converter amplifiers gives 65,536 possible volume steps.

The amplification circuitry of C-3850 consists of a total of 18 unit amplifiers, including I-V assembly, AAVA circuitry, balanced input and balanced output amplifiers.

The Essence of Technology



The Beauty of Tradition



Precision Stereo Preamplifier

As the ultimate analog preamplifier, the C-3850 has been honed to perfection, bringing together sophisticated technology and carefully selected materials in a package of refined visual appeal. The gold-hue front panel and the exquisite wood cabinet reflect true craftsmanship, as the natural wood grain of each individual unit has been mirror-finished by expert hands. The result is a product that exudes a graceful and dignified atmosphere.

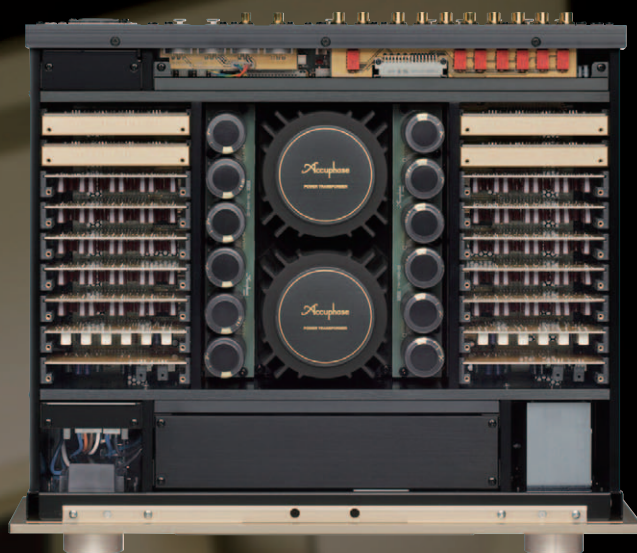

Features and Functions

- Ideal power supply design realizes dual mono construction with newly developed high-efficiency toroidal transformers and filtering capacitors (10,000 μF x 12) selected for sound quality.
- Logic-controlled relays for signal switching assure high sound quality and long-term reliability.
- Versatile arrangement of line and balanced input and output connectors.
- Printed circuit boards for signal transmission are made from glass cloth fluorocarbon resin with low dielectric constant and minimum loss.
- Selectable preamplifier gain with three settings (12 dB, 18 dB, 24 dB).
- EXT PRE function allows use of external preamplifier.
- Output phase selectable individually for each input, with visual indication. When INV LED is lit, output phase is inverted. When LED is out, phase is normal.
- Dedicated headphone amplifier with three selectable gain settings.
- Advanced High Carbon cast iron insulator feet with superior damping characteristics further enhance sound quality.
- Massive wood cabinet with natural grain finish.



High-efficiency toroidal power transformers

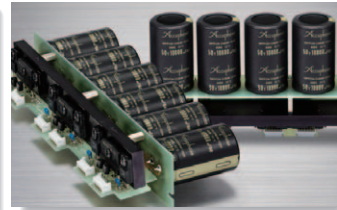

Audio quality filtering capacitors



Assembly with line level and balanced input and output connectors

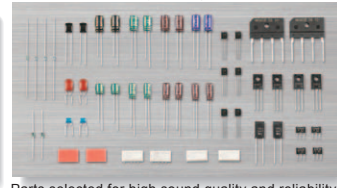

Parts selected for high sound quality and reliability

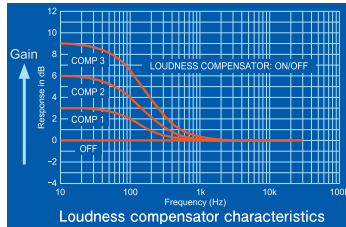

Loudness compensator characteristics

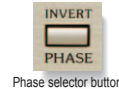

Phase selector button



EXT PRE phase setting indication



Gain selector

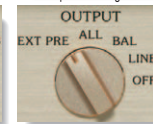

EXT PRE selector



Headphone level selector



Ultra high performance operational amplifiers

- More versatile features:
 - Provisions for recording and playback with a recorder.
 - Attenuator (-20 dB).
 - Loudness compensator with three selectable characteristics enhances low end presence.
 - Alphanumeric indication of input position.
 - Large, easy to read numeric indication of volume level setting.



Unit amplifier assembly

A total of 18 unit amplifiers handle the signal transmission for the left and right channel. The printed circuit boards are made from glass cloth fluorocarbon resin, and the copper foil surfaces are gold-plated. The unit amplifiers are mounted on a glass epoxy motherboard, and left and right sections are kept completely separate. An 8 mm thick frame made of hard aluminum prevents mutual interference by providing electrical shielding and suppressing physical vibrations.

Supplied remote commander RC-210

Allows volume adjustment, input source switching, and other operations.

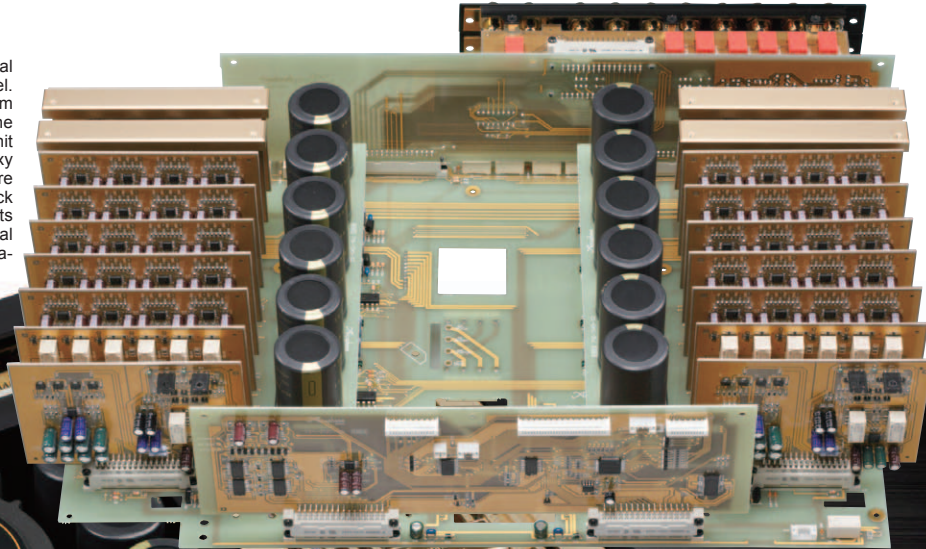

Block Diagram

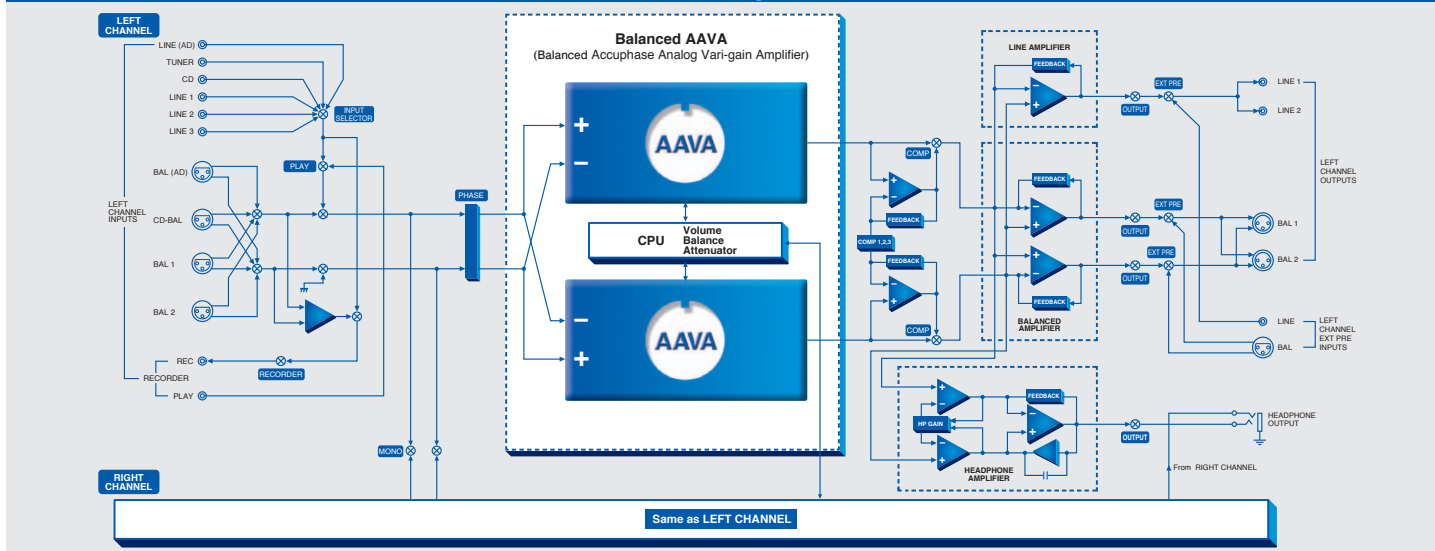

Front Panel

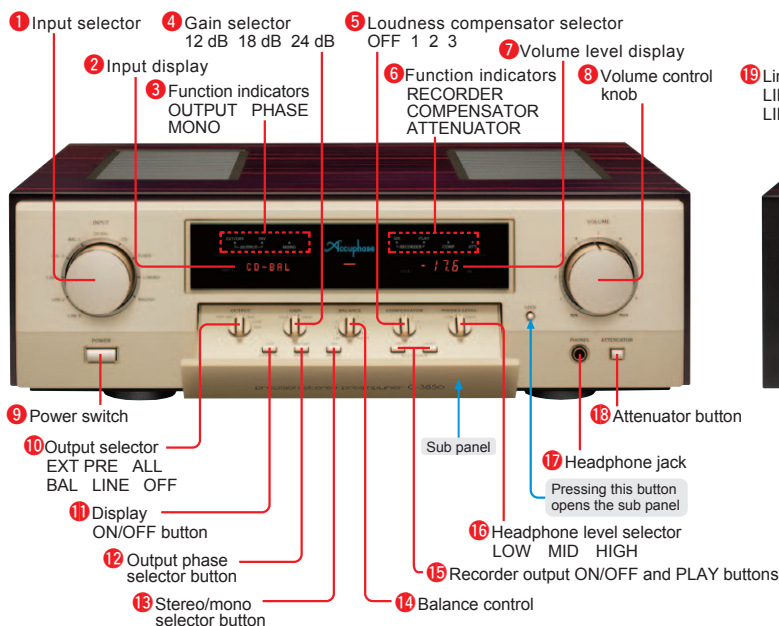

Rear Panel

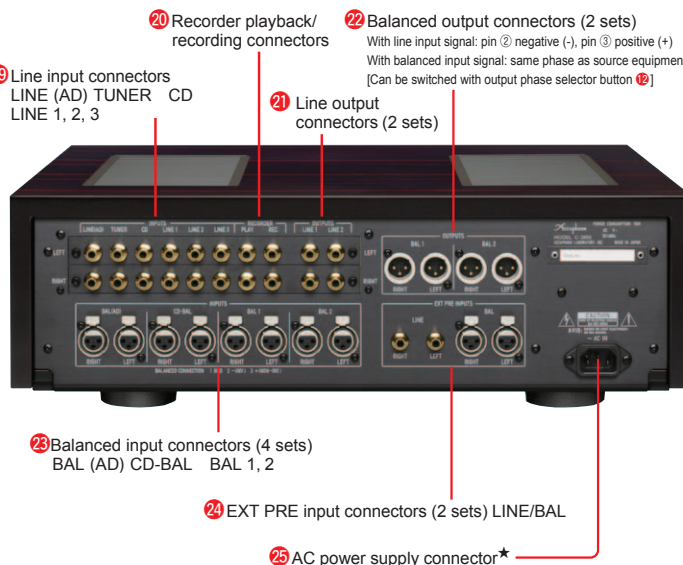

C-3850 Guaranteed Specifications

* Guaranteed specifications are measured according to EIA standard RS-490. * Gain selector set to 18 dB position

- **Frequency Response** BALANCED/LINE INPUT
3 - 200,000 Hz +0 -3.0 dB
20 - 20,000 Hz +0 -0.2 dB

- **Total Harmonic Distortion** (for all inputs) 0.005%

- **Input Sensitivity, Input Impedance**

Input	Sensitivity		Input impedance
	For rated output	For 0.5 V output	
BALANCED	252 mV	63 mV	40 kΩ (20 kΩ/20 kΩ)
LINE	252 mV	63 mV	20 kΩ

- **Rated Output Voltage, Output Impedance**
BALANCED/LINE OUTPUT 2 V 50 ohms

Input	Input shorted, IHF-A weighting	S/N ratio (EIA)
	S/N ratio at rated output	
BALANCED	115 dB	110 dB
LINE	115 dB	110 dB

- **Maximum Output Level** (0.005% THD, 20 - 20,000 Hz)

BALANCED/LINE OUTPUT:	7.0 V
RECORDER REC (with AD input):	6.0 V
BALANCED INPUT:	6.0 V
LINE INPUT:	6.0 V

- **Maximum Input Level**

- **Minimum Load Impedance**

BALANCED/LINE OUTPUT:	600 ohms
RECORDER REC:	10 kilohms

- **Crosstalk** -90 dB or better at 10 kHz (EIA)

- **Gain** (Gain selector: 18 dB) * Gain selector allows increase or decrease by 6 dB, except for REC output.

BALANCED INPUT	→ BALANCED OUTPUT:	18 dB
BALANCED INPUT	→ LINE OUTPUT:	18 dB
LINE INPUT	→ BALANCED OUTPUT:	18 dB
LINE INPUT	→ LINE OUTPUT:	18 dB
BALANCED/LINE INPUT	→ RECORDER REC:	0 dB

- **Loudness Compensation**

1: +2 dB (100 Hz), 2: +4 dB (100 Hz), 3: +6.5 dB (100 Hz)

- **Headphone Jack**

Suitable impedance: 8 ohms or above
Output Level: 2 V (40 ohms)
Gain (LOW, MID, HIGH): ±10 dB from standard MID level

- **Attenuator**

-20 dB

- **Power Requirements**

AC120 V/220 V/230 V, 50/60 Hz (Voltage as indicated on rear panel)

- **Power Consumption** 55 watts

- **Maximum Dimensions**

Width 477 mm (18-3/4")
Height 156 mm (6-1/8")
Depth 412 mm (16-1/8")

- **Mass**

25.0 kg (55.1 lbs) net
32.0 kg (70.6 lbs) in shipping carton

Remarks

- ★ This product is available in versions for 120/220/230 V AC. Make sure that the voltage shown on the rear panel matches the AC line voltage in your area.
- ★ The 230 V version has an Eco Mode that switches power off after 120 minutes of inactivity.
- ★ The shape of the AC inlet and plug of the supplied power cord depends on the voltage rating and destination country.

- **Supplied accessories:**
 - AC power cord
 - Audio cables with plugs ASL-10
 - Remote commander RC-210
 - Cleaning cloth



ACCUPHASE LABORATORY, INC.

F1505Y PRINTED IN JAPAN 850-2192-00(B1)