

# MDS COMPACT DISC PLAYER DP-430



Accuphase Laboratory, Inc.

1

In 2008, Accuphase launched DP-400 which was installed the original dedicated CD drive mechanism into the market.

DP-400 attracted tons of audiophiles and music lovers, and known as the best seller model.

It has been evolved in 2013 as DP-410, then, DP-430 is the 3rd generation of DP-400 series.

Technical high lights of DP-430 are exclusive design for CD playback and achieved ultra low THD and noise performance.

They are inherited from our flagship SA-CD transport DP-950 and digital processor DC-950.

# Front Display

- Easy to see: Sampling Frequency & Number of Quantization Bits

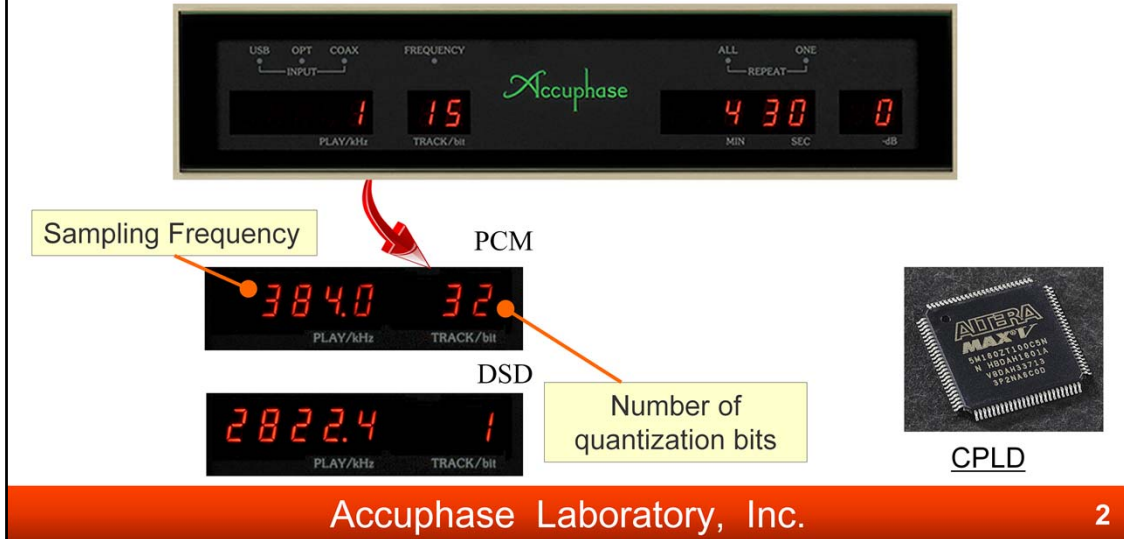

DP-430 can show the sampling frequency and the number of effective bits of all input signals on the front display.

Quantization bits are counted directly from raw data by using a high speed Complicated Programmable Logic Device.

# Dimensions and Weight

- Same unit dimensions and same weight

## DP-430

W: 465 mm  
H: 151 mm  
D: 393 mm

Weight: 14.0 kg



## DP-410

W: 465 mm  
H: 151 mm  
D: 393 mm

Weight: 14.0 kg

DP-430 overview

Accuphase Laboratory, Inc.

3

The dimensions and weight of DP-430 are same as those of DP-410.

Simple but rigid basic structure is inherited from DP-410.

# Transport Mechanism for CD playback

- Highly rigid base construction
- High performance vibration absorber
- Large bridge cover to reduce the operation noise

Silicon  
made  
vibration  
absorber



DP-430 Transport Mechanism

Accuphase Laboratory, Inc.

4

Transport mechanism is an exclusive design for CD playback. The large Bridge cover is very effective for reducing the noise caused from motor drive and the air flow of disc rotation. Furthermore, a laser pickup module is mounted on vibration absorbers. Those are made of the silicon carefully-selected for this mechanism.

# Internal view

- Functional & separated circuit configuration

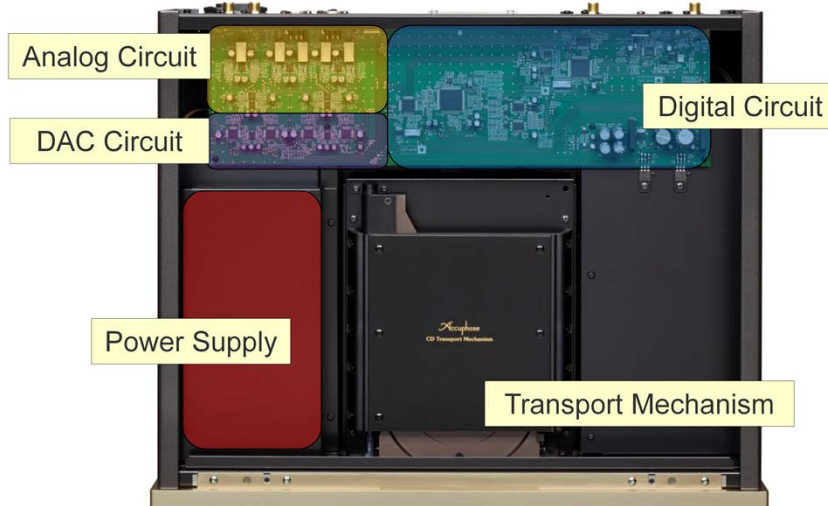

DP-430 Internal View

Accuphase Laboratory, Inc.

5

DP-430 is applied simple but functional module layout. Each circuit block is logically arranged to make the signal path as short as possible.

The digital circuit block is on the right and the analog circuit block is on the left at the back panel side.

Digital high speed line is transferred through fully balanced circuit to avoid from radiating noise.

# Electrical Performance

- Ultra Low Noise

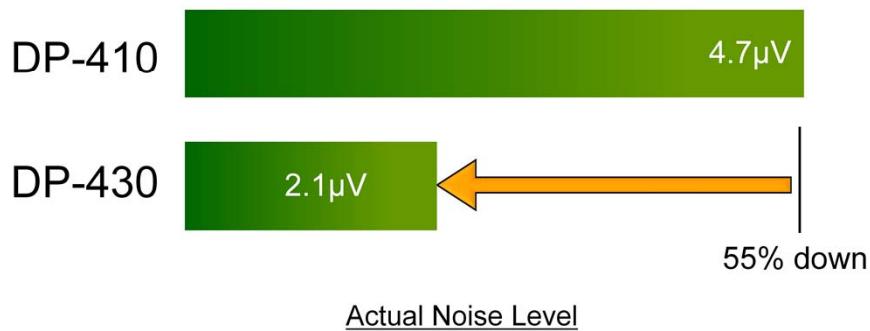

Accuphase Laboratory, Inc.

6

Ultra Low Noise is one of the main technical features of DP-430.

The former model, DP-410 had the excellent noise performance, however, DP-430 achieves 55% lower output noise voltage than DP-410.

DP-430 guarantees 117dB Signal to Noise ratio which means 3.5 $\mu\text{V}$  of output noise voltage.

# Electrical Performance

- Ultra low THD+Noise

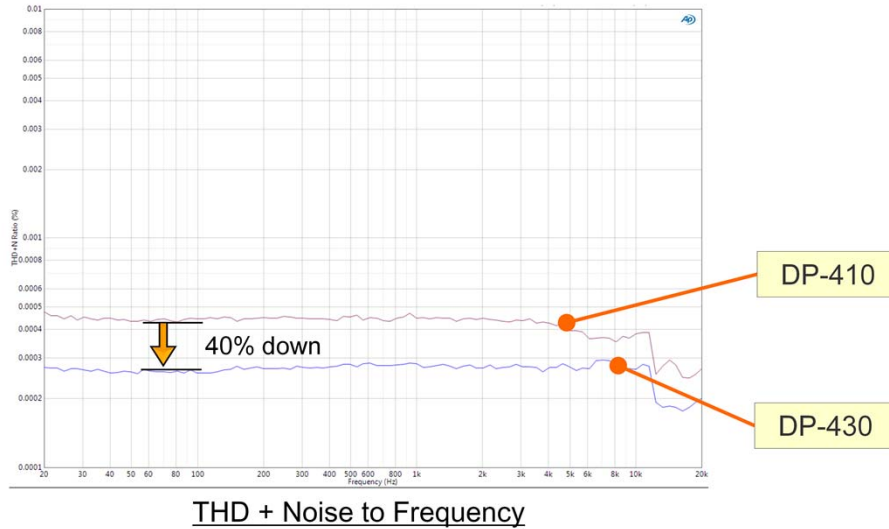

Accuphase Laboratory, Inc.

7

DP-430 proudly shows the great THD+Noise characteristics which are quite important for the quality of music playback.

And this chart clearly proves that DP-430 is superior beyond comparison with the former model DP-410.



## D/A converter

- 4 parallel D/A converters per channel
  - Featured AK4490EQ (AKM Corporation)
  - MDS Architecture for all digital signals
  - ANCC for ultra low noise and distortion



AK4490EQ

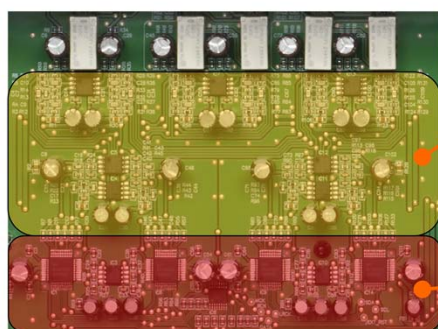

Filter Amp part with ANCC technology

DAC part with MDS technology

DAC and ANCC Circuit

Accuphase Laboratory, Inc.

8

For D/A converter section, Accuphase updates the DAC chip to Asahi Kasei Micro Electronics' Premium DAC AK4490EQ for DP-430.

AK4490EQ has 2 DACs inside, and DP-430 uses 4 DACs connected in parallel per channel with Accuphase's unique technology, MDS (Multiple Delta Sigma) conversion system.

To obtain extreme low distortion and noise performance, Accuphase developed new circuit technology which is named ANCC(Accuphase Noise and distortion Cancelling Circuit).

This technology is for the filter amp circuit that compensates distorted waveform of the circuit.

The circuit works as 4<sup>th</sup> order LPF to reduce the noise from DACs.

And also Fully-balanced structure is employed after D/A converter section in DP-430.



# ANCC

(Accuphase Noise and distortion Cancelling Circuit)

- Noise and distortion improving architecture by using feedback + feedforward method
  - Distortion can be minimal, noise from main-amp and sub-amp is swapped

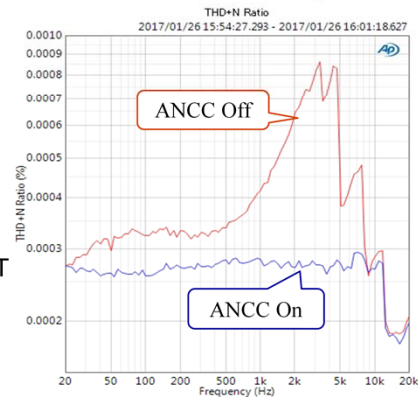
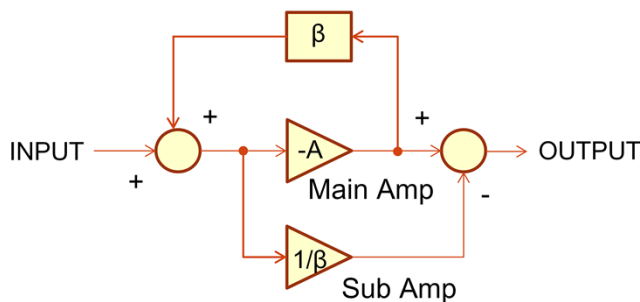

THD + Noise comparison

Accuphase Laboratory, Inc.

9

ANCC is the latest Accuphase's unique technology. To reduce noise from DACs, filter amp needs wide dynamic range and linearity.

High voltage power supply and complicated architecture is required to obtain expected performance.

ANCC needs only general main amplifier and small low noise OP-AMP as the sub-amplifier.

Feedback loop cancels the distortion of main amp, and feedforward loop negates the detected distortion, and this shows the same effects on noise also.

This new technology contributes to make accurate D/A conversion with a simple circuit.

# Digital Inputs / Outputs

- Digital Inputs:
  - USB-B: PCM 384kHz/32bit, DSD 11.2896MHz/1bit
  - Coaxial: 192kHz/24bit
  - Optical: 96kHz/24bit
- Transport Outputs
  - Coaxial: 44.1kHz/16bit
  - Optical: 44.1kHz/16bit



Rear Panel

DP-430 has 3 digital inputs, Coaxial, Optical and USB. USB Input accepts 384kHz/32bit-PCM or 11.2896MHz-DSD. DSD data can be received both DoP ( DSD over PCM ) and ASIO2.1.

Coaxial and Optical Transport outputs are also available. Transport part and DAC part can work separately and it allows users to practice ways of use.

DG-58 can be connected easily between Transport output and Digital input of DP-430.